

50amp RV Outlet Wiring (2 x 50amp – 120v)

CORRECT

Breaker Panel

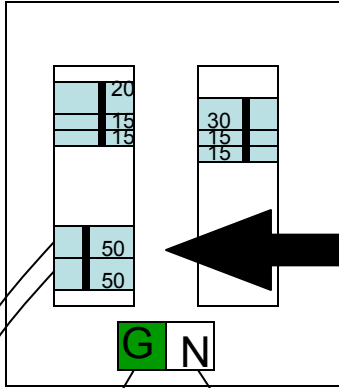

50 amp
Double
Throw
Breaker

G= Ground
N= Neutral

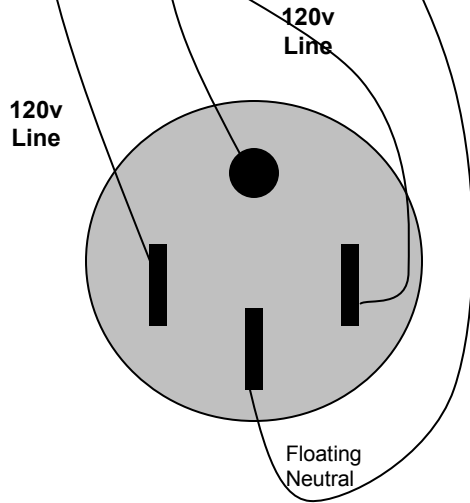

4 Wires from Panel

WRONG

Breaker Panel

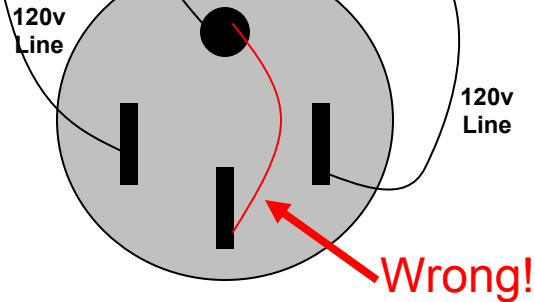
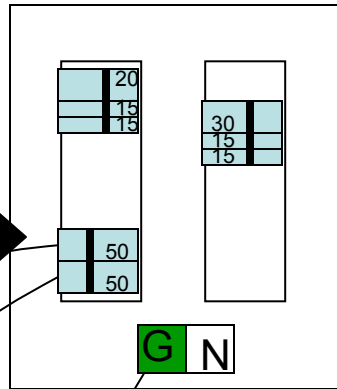

3 Wires &
Jumping the Neutral

30amp RV Outlet (120v)

Breaker Panel

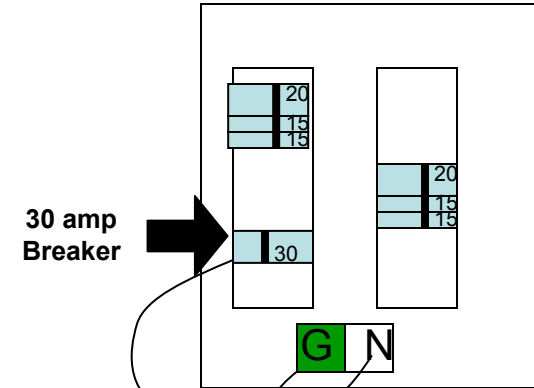

30 amp
Breaker

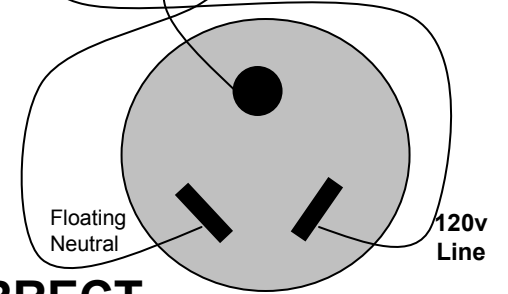

CORRECT

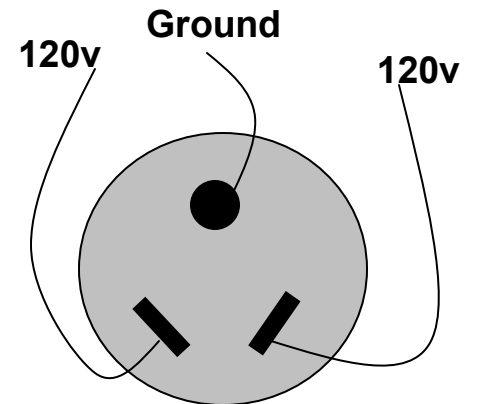

WRONG